

An Uncertainty Analysis of Fluke Calibration Fused-Quartz Bourdon Tube Pressure Products

Speaker/Author: Joshua Biggar
Fluke Calibration
4765 E Beautiful Lane, Phoenix, Arizona 85044
Phone: (602)-773-4765
joshua.biggar@flukecal.com

1 Abstract

The forced-balanced fused-quartz Bourdon tube (QBT) technology is a proven pressure measurement method, which has been used in the metrology field for over 50 years. In the summer of 2010, Fluke Calibration acquired Ruska Instrument Corporation from General Electric's Sensing and Technologies division which added this unique, high-performance pressure measurement technology to the Fluke Calibration family of pressure products. The celebrated pedigrees in Fluke Calibration's pressure coterie that employ QBT technology are the 7000 Series pressure products. 7000 Series pressure controllers and indicators, descend from a heritage of unmatched performance and residence in the metrology community. This paper aims at explaining the unique facets of QBT technology, basis of operation and the uncertainty classes available.

2 Learning Objectives

Readers and attendees will learn about the design of a QBT and how it is used to measure pressure in type 7000 controllers. Additionally, readers will learn about parameters that influence QBT measurement and the associated uncertainties to consider during use and calibration.

3 Introduction

Fluke Calibration now manufactures products that utilize QBT sensor technology. The fused-quartz Bourdon tube should not be confused with the Quartz Reference Pressure Transducer (Q-RPT), found in other eminent Fluke Calibration pressure products. The Q-RPT is fundamentally a quartz resonant sensor with a metallic sensing element – not quartz. The advantage of using an all quartz sensor, makes QBT ranged 7000 Series instruments one of the most precise secondary standards commercially available. A secondary standard relies on its output being transferred from a primary standard, such as a piston gauge. Therefore, a secondary standard must be adjusted and calibrated to output a correct pressure. The intent of this paper is to educate users on QBT technology as used in Fluke Calibration 7000 Series pressure products and typical uncertainty considerations that affect the measurement uncertainty of the instrument.

4 Why Fused-Quartz?

4.1 Physical Properties

Fused-quartz is a high purity glass with many unique physical and chemical properties that make it an ideal material for a high-precision sensing element. Although there are many physical properties of fused-quartz that exceed the scope and intent of this paper, Fluke Calibration embraces the exclusive properties of fused-quartz for use as a pressure sensing element; such as its stability, high elasticity, low hysteresis and excellent fatigue strength [1].

Linear Coefficient of Thermal Expansion

Fused-quartz is probably best known for its very low linear coefficient of thermal expansion, with a mean value of approximately $0.55 \times 10^{-6} / ^\circ\text{C}$ [2]. This is a fundamentally low value and allows quartz to withstand extremely large thermal gradients without severe deformation or fracturing like other types of glass.

Tensile and Compressive Strength

The fused-quartz manufacturing process at Fluke ensures that all quartz Bourdon tubes are machined and handled properly to limit factors that can reduce surface integrity. Quartz's tensile and compressive strengths are highly dependent on the surface integrity of the component. The average tensile strength of quartz Bourdon tubes is between 48 to 55 MPa (7,000 to 8,000 psi). This translates to a maximum working pressure that a fused-quartz Bourdon tube can have and still maintain a sufficient safety factor in the range of 17 to 20 MPa (2,500 to 3,000 psi) [2]. If pressure can be applied on the outside of the quartz Bourdon tube, in a compressive state, rather than an outward tension (pressurizing the inside diameter of the helix), the maximum allowable pressure can approach 690 MPa (100,000 psi) primarily due to quartz's average compressive strength of approximately 1.17 GPa (170,000 psi) [2]. Due to safety concerns of high-pressure gas systems, cost and weight of materials available to house the sensor and alternative systems available, Fluke recommends that quartz only be used as a pressure sensor up to 17 MPa (2,500 psi).

Elastic Properties

Fused-quartz is the most perfectly elastic material on Earth, which makes quartz the ideal material for a precision flexure [2]. However, its elastic modulus thermal coefficient is rather high at $1.34 \times 10^{-4} / ^\circ\text{C}$, meaning that quartz actually gets stronger with an increase in temperature until the strain point is reached [2]. This is the reasoning why the sensor housing is thermally controlled; to establish a constant temperature environment thus, reducing the elastic modulus thermal coefficient. The uncertainty attributed to thermal control is included in the precision specification of the sensor.

5 Transducer Module

Figure 1 shows a typical 7000 Series transducer module. The transducer module consists of the fused-quartz Bourdon tube pressure sensor, two-piece aluminum housing, light source with photo cell assembly, a flexible heater strip and the interface to the sensor board.

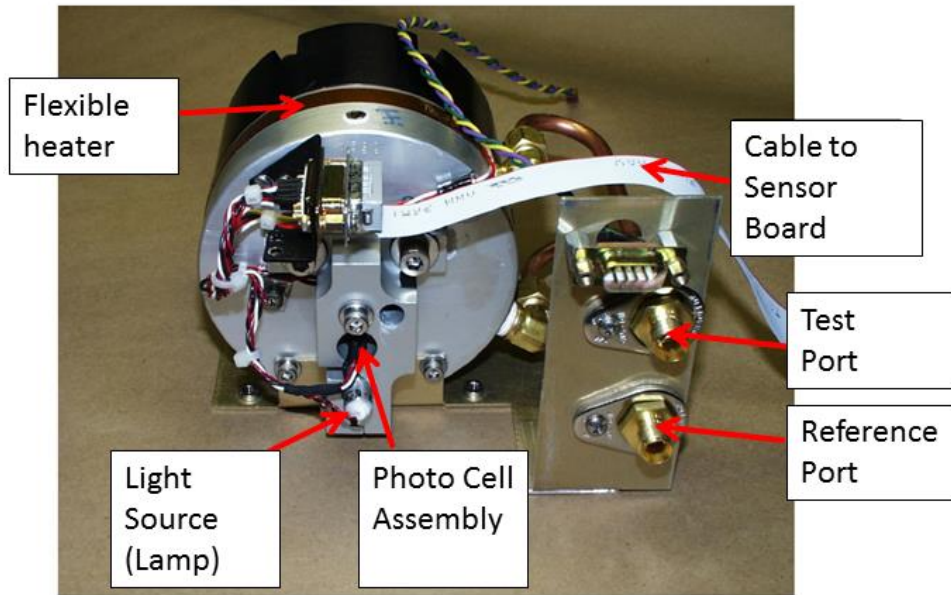

Figure 1. Quartz Bourdon Tube Transducer Module.

5.1 Quartz Bourdon Tube Sensor

The QBT sensor is mounted in a thermally regulated machined aluminum housing as shown in Figure 1. The sensor is comprised of a hollow helix quartz Bourdon tube mechanism with a curved, polished mirror affixed to one end as shown in Figures 2 and 3. A rigid quartz support beam is anchored transverse to the axis of rotation of the helical tube which supports two electromagnetic coils, suspended in a field of permanent magnets that are secured to the sensor housing.

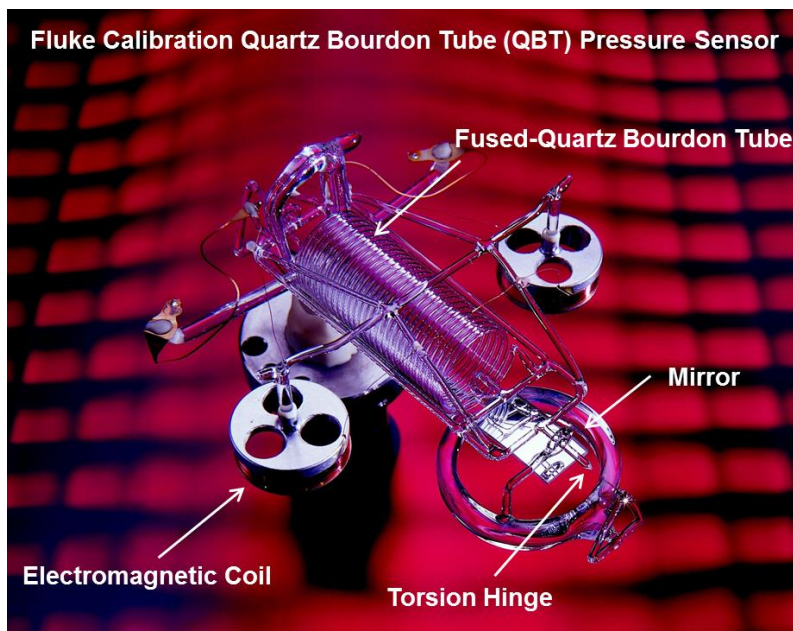

Figure 2. Fluke Quartz Bourdon Tube Sensor Assembly (Photograph).

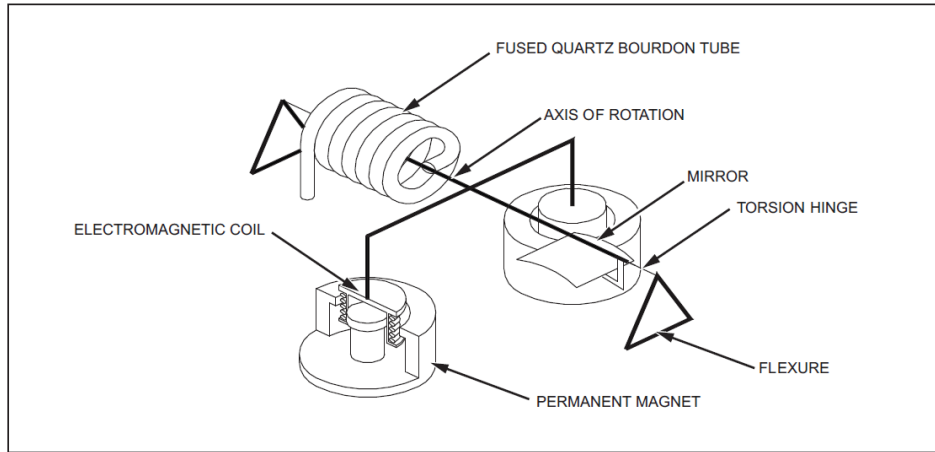

Figure 3. Fluke Quartz Bourdon Tube Sensor Assembly (Drawing).

A lamp assembly concentrates a beam of light through a quartz window onto the mirror affixed to the helical tube. The mirror reflects light back through the window illuminating a pair of balanced photodiodes as shown in Figure 4. When there is zero pressure differential across the helical tube, the photodiode assembly is attuned so that the light beam is equally focused between each photocell; this establishes the “zero position”. In the zero position, the outputs of the two photodiodes provide energy used to maintain the quartz assembly in its zero position creating a force balance condition.

When a change in pressure is realized on the helical tube, the entire apparatus attempts to rotate causing the mirror to direct the reflected light beam to illuminate more on one photodiode than the other. The sensor board actively responds by changing the current to the electromagnetic coils that, through interaction with the fixed permanent magnets, force the helical tube to return to its zero position. The amount of current required to do this is directly proportional to the pressure applied across the helical tube. Figure 5 illustrates the continuous current feedback loop of the QBT assembly. The current is passed through a precision resistor, designated as “R”, creating an analog voltage directly proportional to the pressure in the system. In essence, pressure is determined by the amount of current required to return the helical tube back to its zero position.

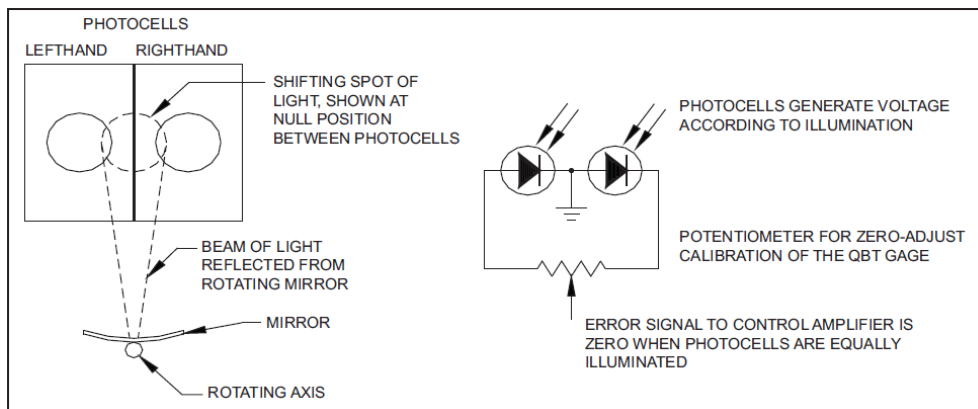

Figure 4. Photodiode Assembly.

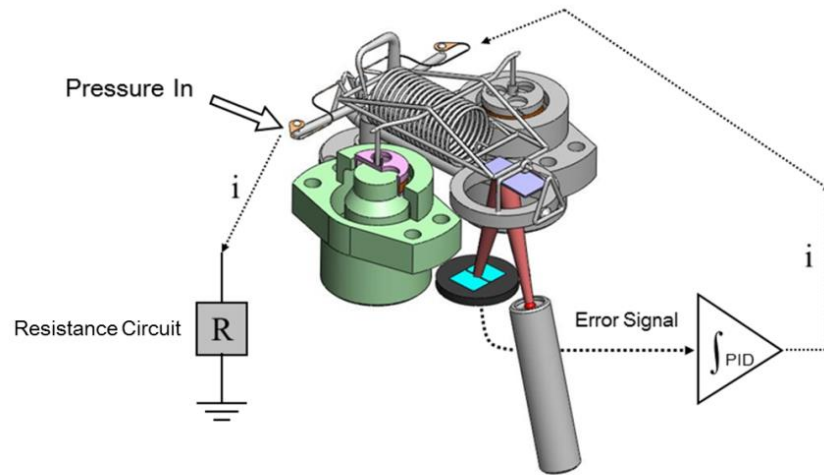

Figure 5. QBT Current Feedback Loop.

5.2 Sensor Board

The sensor board is responsible for analyzing the critical parameters that facilitate transducer module operation. At a higher level, the sensor board interfaces with a temperature sensor, the transducer module and vacuum sensor (if option installed). Thermal regulation of the sensor housing assembly is controlled by the sensor board. The housing is set to be maintained at 50 °C in order to create a constant and controllable environment. A controlled sensor environment is important due to the many external environmental influences that can affect pressure measurement such as, tubing material, tubing temperature and local air velocity to name a few.

6 Uncertainty Considerations

Because of the possible variances in use and calibration, it is necessary to examine common boundaries that can influence the final uncertainty of the instrument. To effectively account for pressure errors, the type and source of the error must be known along with its polarity and magnitude. The following conditions should be considered when estimating the uncertainty of the instrument.

- Precision Specifications
- Operating Mode
- Orientation
- Fluid Media
- Environment
- Short Term Stability
- Long Term Stability
- Reference Uncertainty
- Control Precision

6.1 Precision Specifications

In the paragraphs below, performance specifications are categorized for each precision class of 7000 Series instruments. Precision is one of the most important characteristics of a sensor used as a secondary standard. Precision includes the combined effects of linearity, repeatability and hysteresis. Unless otherwise noted, precision specifications are stated at a 95% level of confidence ($k=2$).

Linearity

Linearity is an error from deviations of the linear output of the pressure sensor. Linearity is considered to be independent from one instrument to another but should remain consistent for subsequent calibrations. If there is a change in linearity which causes the instrument not to meet specifications the onboard adjustment routine can be performed for QBT instruments.

Repeatability

Repeatability is the ability of the sensor to repeat a pressure when subjected to the same pressure and conditions in a relatively short time frame. Repeatability is measured by reproducing each test point in the same manner multiple times, ideally in the method of completing duplicate cycles.

Hysteresis

Hysteresis is an error from an influence that is dependent on the mechanical memory of the sensor. Like linearity and repeatability, hysteresis is tested during the factory characterization and calibration process. Based on the physical and chemical properties of fused-quartz and the design of the QBT sensor module, there should not be any significant influence of mechanical memory introduced from ascending and descending pressure excursions. This is the basis on why only ascending points are standard on QBT ranged instruments. It is possible that measured QBT pressure may exhibit what may look like classical hysteresis when performing descending pressure points. This may be attributed to a combination of zero drift and thermal instability. Trace amounts of liquid contamination can induce the QBT to not react as designed and performance may appear hysteresis-like. It is critical that the QBT module be kept clean and free from sources of contamination.

6.2 7000 Series Pressure Products Measurement Performance Classifications

Fluke Calibration 7000 Series pressure products consist of two main categories; pressure controllers and precision pressure indicators. These products are available with QBT ranges up to 17 MPa (2,500 psi), with the exception of the low pressure variant (LP) which is focused on draft pressure ranges up to 25 kPa (100 inH₂O) and the Q-RPT ranged high pressure model 7250HP is available with a full scale pressure range of 20 MPa (3,000 psi) [3]. All 725x and 705x models are intended for pneumatic use only and are available in any configuration that covers a pressure range of -100 kPa to 20 MPa (-15 to 3,000 psi). Figures 6 through 10 graphically represent the basis of range and point configuration for each QBT precision class. In the related figures, the bottom line, signified by a red circle denotes the QBT range(s). The middle line represented by a blue square defines the points to align the sensor(s). The designated adjustment points are part of the internal adjustment routine and are set by Fluke Calibration; they are not user selectable. The

top line expressed as a green triangle itemizes Fluke Calibration’s recommended calibration points. The calibration points selected benefit a specific purpose; to verify in-between the adjustment points.

6.3 Standard Class

Positive Gauge Precision

Models in the standard precision class are considered “full scale” devices because the precision specification is calculated based exclusively on the full scale of the QBT. This class supports a precision rating of $\pm(0.003\%$ of FS). For full scale ranges up to 17 MPa (2,500 psi), models are available with one, single-ranged QBT, identified in Figure 6 as 0 to 100% of full scale. For full scale ranges greater than 17 MPa, the product is designated as 7250HP, which utilizes a different measurement technology is not covered in this paper.

Negative Gauge Precision

There is not a separate negative gauge precision specification for instruments in this class.

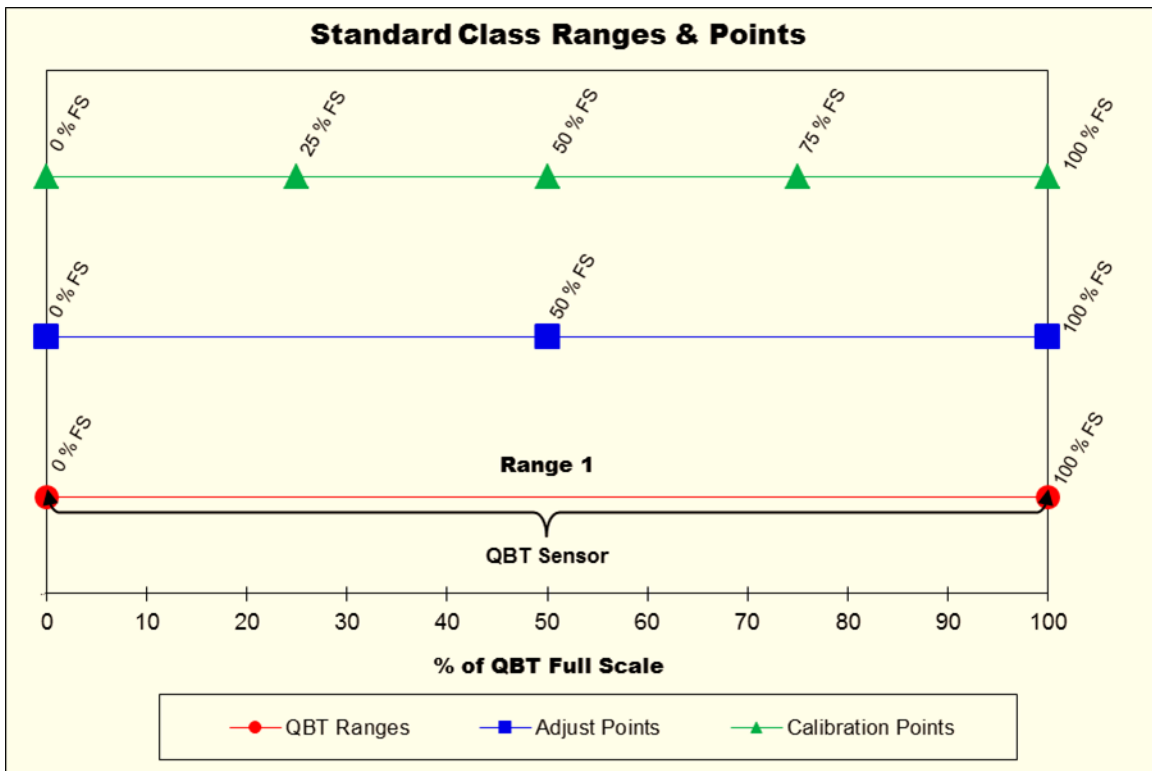

Figure 6. Standard Class QBT Ranges and Points.

6.4 i Class

Positive Gauge Precision

The i precision class offers a higher level of performance than the standard precision class. 7000 Series i models provide a precision rating of $\pm(0.005\%$ of reading from 25% to 100% of FS) utilizing one dual-ranged QBT. For positive pressure values below 25% of FS, the precision is calculated as a percent of reading of the precision threshold pressure; $\pm(0.005\%$ of 25% of FS), more commonly expressed as $\pm(0.00125\%$ of FS). Figure 7 illustrates the first range as 0 to 50% of full scale and the second range as 50 to 100% of full scale. Having two ranges on one QBT allows for a better linearization model than the single ranged standard class QBT. Fluke Calibration's multi-range pressure calibration system, the 7250SYS and the 7750i Air Data Test Set (ADTS) are members of this precision class.

Negative Gauge Precision

For instruments in this class with the negative gauge option, the negative gauge precision specification is calculated as the greater of 5.17 Pa (0.00075 psi) or $\pm(0.005\%$ of 25% of FS).

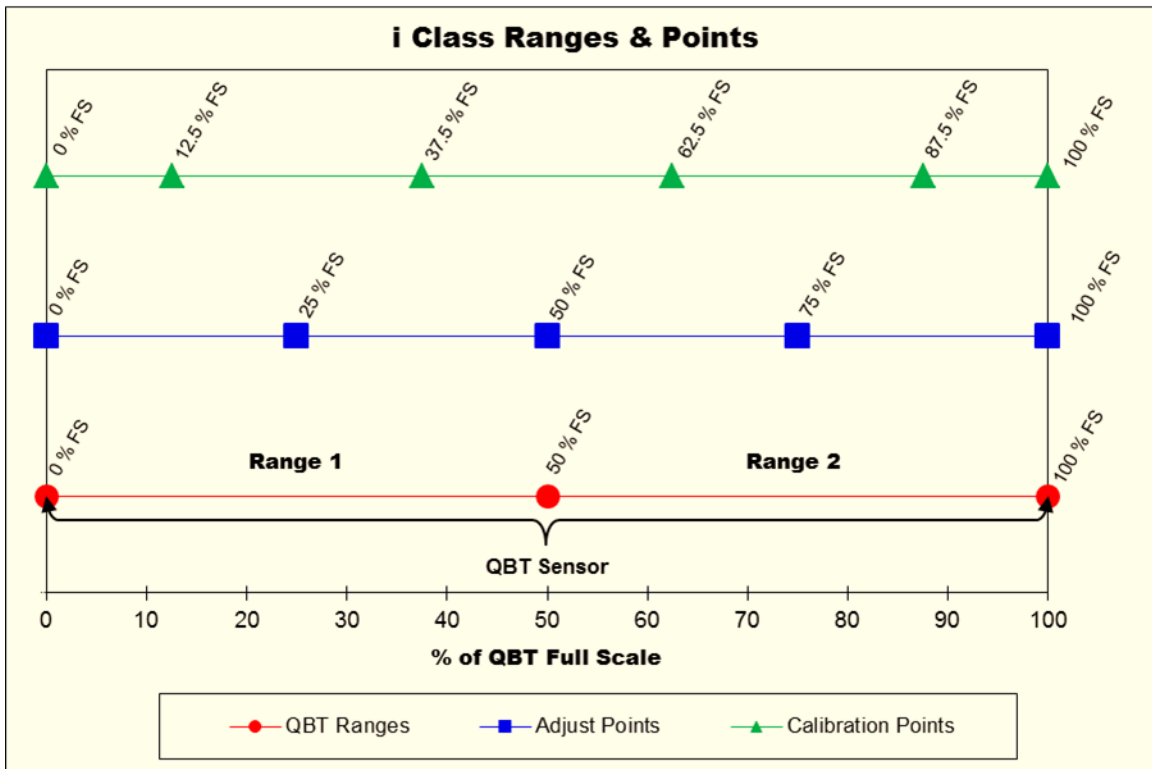

Figure 7. i Class QBT Ranges and Points.

6.5 xi Class

Positive Gauge Precision

The xi precision class offers more advanced precision than the i precision class. These products present a precision specification of $\pm(0.005\%$ of reading from 5% to 100% of FS). For positive pressure below 5% of full scale, precision can be calculated as $\pm(0.005\%$ of 5% of FS), more commonly expressed as $\pm(0.00025\%$ of FS). The increased performance of the 7250xi is achievable due to utilizing two dual-ranged QBT transducer modules as shown in Figure 8. The 7250xi can achieve a percent of reading precision rating down to 5% of the full range due to utilizing a lower range QBT with a FS that is typically equal to 25% of the instrument's full scale.

Negative Gauge Precision

For instruments in this class having the negative gauge option, the negative gauge precision specification is calculated as the greater of 5.17 Pa (0.00075 psi) or $\pm(0.005\%$ of 5% of FS).

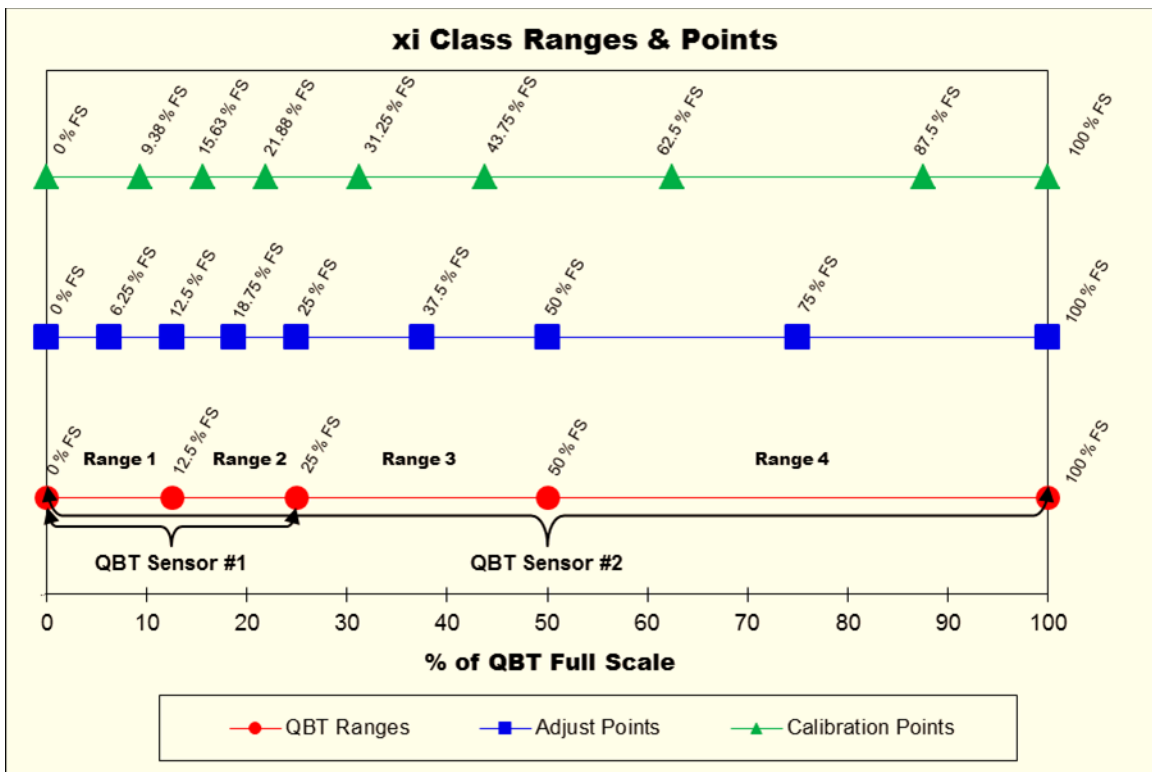

Figure 8. xi Class QBT Ranges and Points.

6.6 LP Class

Precision

The LP or “low pressure” precision class is a purposeful variant of the i precision class. Just like i class products, the LP utilizes a single, dual-ranged QBT. The differences are in the precision threshold and the negative gauge precision specification. The precision threshold is 10% of positive FS as opposed to 25% of positive FS. The LP provides a precision specification of $\pm(0.005\%$ of reading from 10% to 100% of FS) and $\pm(0.005\%$ of 10% of positive FS), more commonly expressed as $\pm(0.0005\%$ of FS) for 0 to 10% of positive FS.

Negative Gauge Precision

For instruments in this class that are configured for bi-directional operation, the precision specification in the negative region is identical to the corresponding positive region.

6.7 Negative Gauge Ranges

It should be noted that an instrument with the negative gauge option is dependent on the positive full scale of the QBT sensor. For any positive full scale range less than 100 kPa (14.50377 psi), the maximum negative gauge full scale is equal to the positive full scale (Figure 9). For example, if the positive full scale of the range is 35 kPa (5 psi), the negative gauge full scale would equal -35 kPa (-5 psi). For QBT ranges greater than or equal to 100 kPa, negative gauge full scale is equal to -100 kPa (-14.50377 psi) as indicated in Figure 10.

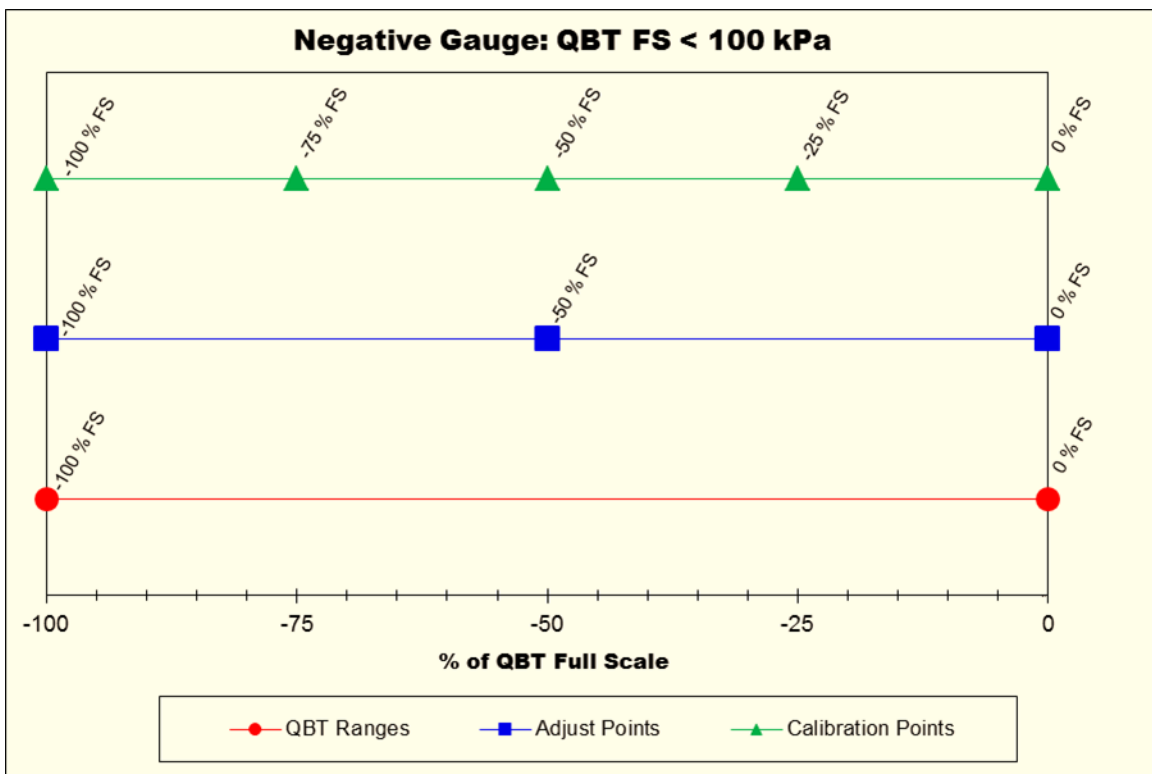

Figure 9. Negative Gauge Ranges < 100 kPa.

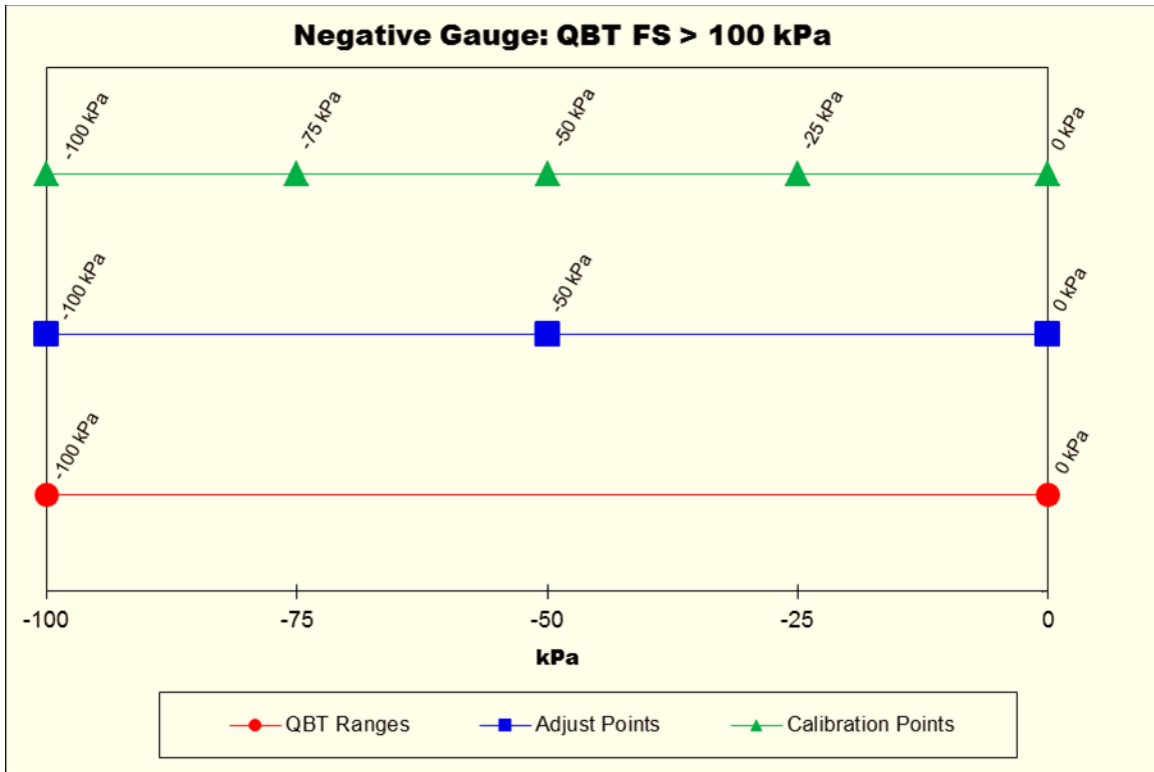

Figure 10. Negative Gauge Ranges >100 kPa.

6.8 Operating Mode

Native operating modes supported by 7000 Series instruments are either absolute or gauge. On native gauge instruments, absolute mode is obtained either by use of a precision barometric sensor (absolute by addition of atmospheric pressure), referred to as Absolute by Addition of ATM or internal vacuum sensor, referred to as Vacuum Reference Absolute. Table 1 lists the operating modes currently available by model type.

Table 1. 7000 Series Operating Modes.

Model	Gauge	Absolute by Addition of ATM	Vacuum Reference Absolute	Permanent Absolute
7050/7250/7252	✓	✓	✓	✓
7250SYS	✓	✓	✓	✓
7050i/7250i/7252i	✓	✓	✓	✓
7750i	✓	N/A	N/A	✓
7250xi	✓	✓	N/A	N/A
7050LP/7250LP	✓	N/A	N/A	N/A

Absolute by the Addition of Atmospheric Pressure

Applies to instruments configured with the barometric sensor option. Gauge instruments with QBT ranges of 103 kPa (15 psi) and greater can operate as absolute by addition of ATM instruments. This means that the reference port of the QBT is continually monitored by a

precision barometric sensor. The barometric sensor output is added to the gauge mode sensor output resulting in a final absolute pressure. The one year specification of the barometric sensor is estimated to be less than or equal to $\pm(13.8 \text{ Pa (0.002 psi) per year}$) at a 95% level of confidence. When operating in absolute by addition of ATM mode, it is recommended that the uncertainty of the barometric sensor be combined by the square root of the sum of the squares (RSS) with the gauge mode equivalent QBT uncertainty.

Vacuum Reference Absolute

Applies to instruments configured with the vacuum sensor option. An alternative option for gauge mode instruments to operate in absolute mode is by use of a vacuum sensor internally coupled to the QBT reference port. Vacuum Reference Absolute instruments require a dedicated vacuum pump to remove air from the reference port of the sensor. It is recommended that a vacuum level of at least 13.33 Pa (100 mTorr) be attained to achieve the lowest uncertainty of the vacuum sensor. The one year specification of the internal vacuum sensor is estimated to be the greater of $\pm(10\%$ of reading (the residual case vacuum pressure) or 1.33 Pa (10 mTorr)) at a 95% level of confidence. Fluke suggests that the uncertainty of the vacuum sensor be combined RSS with the gauge mode equivalent QBT uncertainty. Not zeroing the QBT when in Vacuum Reference Absolute mode (correcting for case effect errors) could impose a zero shift error estimated to be less than or equal to $\pm(0.010\%$ of full scale) per ATM of exposure.

Permanent Absolute

Permanent or true absolute instruments have a permanently evacuated QBT. The inside diameter of the helical quartz Bourdon tube is evacuated to a vacuum level less than 13 mPa (0.1 mTorr) then permanently sealed at the factory. In this configuration, test pressures can only be applied to the sensor case (on the outside of the helical Bourdon tube) and are measured with respect to vacuum. The maximum full scale sensor available in this configuration is 345 kPa (50 psi), primarily due to pressure limits of the zeroing vacuum sensor. Fixed absolute instruments utilize a vacuum sensor similar to Vacuum Reference option instruments, except that the purpose of the vacuum sensor is only used to zero the QBT to correct for zero drift and case effect errors. The same specification of the vacuum sensor applies.

Simulated Gauge (Tare Mode)

Tare mode, also known as simulated gauge mode is only available on permanent absolute QBT's. For users that want the performance of a true absolute QBT and to also function as a gauge calibrator, this option allows the absolute reading to be tared for simulated gauge mode operation. In simulated gauge mode there is not any dynamic atmospheric pressure compensation to the measured value, unless the instrument is a dual channel instrument configured with a precision barometric sensor on the opposite channel. Otherwise, the unit must be tared frequently to compensate for changes in atmospheric pressure.

6.9 Orientation

Because of QBT sensing technology, 7000 Series instruments pressure output can be sensitive to orientation. It is recommended that the instruments are calibrated and used in a level position when at all possible. The specification for zero pressure tilt sensitivity is measured to be less than or equal to $\pm(0.002\%$ FS/degree) from a level position. For applications where the instrument

may not be perfectly level, tilt sensitivity can be reduced if the instrument is zeroed and remains in this position for the duration of its use between re-zeroing.

6.10 Fluid Media

The fluid media used has some influence on the final uncertainty calculated for the instrument. This is fundamentally because of the fluid head height differences between the reference planes of the 7000 and the Unit Under Test (UUT) or reference, normally referred to as head pressure. All 7000 Series instruments can automatically correct for head differences taking into account the density of the medium used. Only clean, dry gas media is approved for use with QBTs. The uncertainty in fluid head pressure depends on how well the height can be measured, the media being used and how well the density of the media is known. However, fluid head error can be eliminated if the reference plane of measurement between instruments is in line with the reference level of the 7000, making the difference zero.

The purity of the media is important to prevent premature degradation of quartz related performance. Table 2 lists the specifications for Air and Nitrogen (N₂).

Table 2. Fluid Media Specifications.

N ₂ or Air	
Maximum Particle Size:	≤ 0.0013 mm (50 μinches)
Maximum Moisture Content:	-50 °C dew point
Maximum Hydrocarbon Content:	< 30 ppm

6.11 Environment

As long as ambient humidity is in the range of 5% to 95% and that it is non-condensing, the only environmental influences that typically cause measurement errors and need to be accounted for are ambient temperature and vibration. 7000 Series instruments are specified to perform in the temperature range of 18°C to 36°C. Rate of temperature change does not have a significant effect on the QBT since it is temperature controlled but extreme temperature changes may affect QBT heater control, resulting in the on-board software to prevent pressure ready conditions until the QBT temperature is stable. Physical impacts and high frequency vibration could introduce zero drift errors and mechanical settling of the light/photocell assembly. Any zero shift errors that occur during operation can be negated when the instrument is re-zeroed. It is recommended that all vibration sources be controlled and monitored.

6.12 Short Term Stability

Short term stability relates to the zero drift characteristics of the QBT. When the same pressure is applied equally to both, the test and reference ports, the amount of offset from zero is considered zero drift. Zero drift is classified as short term because it can be significantly reduced at time of use by re-zeroing the instrument. The magnitude of zero drift can be assessed based on the length

of time between re-zeroing the instrument. Typically, zero drift will improve with sensor age. The zeroing process does not correct for any changes in slope or span shift errors. Change in slope can only be corrected by adjustment and calibration. Table 3 indicates the 24 hour zero drift specification for each model in the series and the zero drift specification typically experienced during a two hour period at a 95% level of confidence.

Table 3. QBT Zero Drift Specification.

Model	Zero Drift Specification for 24 hours [±]	Zero Drift Specification for 2 hours [±]
7050/7250/7252	≤0.004%FS	≤0.00033%FS
7250SYS		
7050i/7250i/7252i/7750i	≤0.002%FS	≤0.00017%FS
7250xi	≤0.001%FS	≤0.00008%FS
7050LP/7250LP	≤0.006%FS	≤0.0005%FS

6.13 Long Term Stability

Long term stability refers to the change in slope of QBT output over time. Typically worst case span drift is realized at full scale pressure and is calculated as the offset from the true value. QBT's are known to drift proportionally with time; therefore, if the calibration interval was reduced in half to 180 days, the stability specification can also be reduced by half. The uncertainty for slope stability for all QBT instruments is $\pm(0.0075\%$ of reading per year) at a 95% level of confidence. This specification is useful in helping users determine how often the instrument needs to be calibrated to ensure its output meets specifications.

6.14 Reference Uncertainty

The recommended reference technology for calibrating QBT's in 7000 Series instruments is a piston gauge. There are alternative devices that could be used to calibrate a limited range in pressure, for example, a mercury manometer. However, mercury manometers are usually commercially available in ranges up to 350 kPa [4], which only supports a small population of 7000 Series ranges. Piston gauges are recommended based on their ability to regulate pressure with uniform stability and their inherent ability to repeat a pressure [5]. The uncertainty in pressure contributed by the reference is dependent upon the full scale range of the sensor under test.

6.15 Control Precision

Control precision should be accounted for when the instrument is in control mode. The control precision or pressure noise is defined as how close the controller can maintain the pressure to the commanded set point. When in active control mode, the control precision specification is estimated to be $\pm(0.001\%$ of full scale) at a 95% level of confidence. This adder is strictly related to the control stability and the noise encountered when the internal valves are actively adding and removing gas. When the valves are not actively controlling pressure the system is in measure

mode and this uncertainty does not apply. It should be noted that the when calibrating an instrument using a 7000 controller the variations in pressure experienced will be captured in the type A uncertainty of the calibration being performed. Including a control precision as an additional uncertainty would be considered including the same uncertainty twice.

7 Conclusion

7.1 Combining Uncertainties

Uncertainty contributors for 7000 Series instruments can be categorized into two types of uncertainties; relative and threshold. A relative uncertainty is entered as a percent value (% of reading) and is multiplied by the current pressure to calculate the relative uncertainty. Threshold uncertainties are constants. Threshold values can be calculated from a % of full scale specification or a pressure unit specification. For typical applications of Fluke Calibration 7000 Series QBT products the relative and threshold uncertainties are normalized to uncertainties in pressure units and combined RSS as indicated below as the simplified uncertainty calculation. The example provided in Table 4 is for a typical 7250 Pressure Controller/Calibrator with a full scale QBT of 50 psi for a period of 365 days. A zero drift specification of two hours is used in this example.

Table 4. One Year Uncertainty Budget for 7250 Standard Class 50 psi full scale QBT.

	Gauge Mode	Absolute by ATM	Vacuum Reference Absolute	Permanent Absolute
Relative Uncertainties (95%)	[% of rdg]	[% of rdg]	[% of rdg]	[% of rdg]
Reference Uncertainty	0.0012	0.0012	0.0012	0.0012
Stability	0.0075	0.0075	0.0075	0.0075
Fluid Head	0.0010	0.0010	0.0010	0.0010
Threshold Uncertainties (95%)	[% of FS]	[% of FS]	[% of FS]	[% of FS]
Reference Uncertainty	0	0	0	0
Precision	0.003	0.003	0.003	0.003
Zero Drift	0.00033	0.00033	0.00033	0.00033
Zero Tilt	0	0	0	0
Control Stability	0	0	0	0
Barometric Option	0	0.004	0	0
Vacuum Option	0	0	0.00039	0.00039
Combined Relative Uncertainties (95%)	0.0077	0.0077	0.0077	0.0077
Combined Threshold Uncertainties (95%)	0.0030	0.0050	0.0030	0.0030

In this example, the relative portion of the uncertainty is the same for all modes and QBT type. The threshold uncertainty will vary depending on the mode of use. It is recommended that for a full uncertainty analysis, that individual uncertainties be categorized into the applicable type of uncertainty and listed as one standard uncertainty. The uncertainties should then be combined by root sum squaring the individual uncertainties and multiplied by an appropriate factor of k to provide a level of confidence based on the effective degrees of freedom and confidence level desired.

Below is a summary of the final uncertainties from the example in Table 4.

$$U_{\text{Pressure Uncertainty}} = \sqrt{(\text{Relative Uncertainties})^2 + (\text{Threshold Uncertainties})^2}$$

$$U_{\text{Gauge}} = \sqrt{(0.0077\% \text{ of reading})^2 + (0.0030\% \text{ of full scale})^2}$$

$$U_{\text{Absolute by ATM}} = \sqrt{(0.0077\% \text{ of reading})^2 + (0.0050\% \text{ of full scale})^2}$$

$$U_{\text{Vacuum Reference Absolute}} = \sqrt{(0.0077\% \text{ of reading})^2 + (0.0030\% \text{ of full scale})^2}$$

$$U_{\text{Permanent Absolute}} = \sqrt{(0.0077\% \text{ of reading})^2 + (0.0030\% \text{ of full scale})^2}$$

For the i and xi classes, the precision uncertainties would move to the top of the uncertainty budget and the rest would be the same. Each range for a type 7000 controller would need to be evaluated individually.

This paper provides the basis for a complete product uncertainty analysis to be used by the manufacturer to define specifications for the population of these pressure controllers.

8 References

1. Series 6000 Pressure Gauges Catalog. Ruska Instrument Corporation. Catalog number 6000-86, 1986, pg. 2.
2. Fused Quartz Technology for Analytical Instrumentation Applications Application Note, Ruska Instrument Corporation. Application Note number 9804-0089, 1998.
3. Uncertainty of Fluke Calibration 7250HP Technical Note, Fluke Calibration, technical note number 4057579A A-EN-N, August 2011.
4. C.R. Tilford, Pressure and Vacuum Measurements, Chapter 2 in Physical Methods of Chemistry, Second Edition Volume Six: Determination of Thermodynamic Properties, Wiley, 1992, pp. 110-111.
5. M. Bair, Guide To Determining Pressure Measurement Uncertainty For Q-RPT Based Products Technical Note, Fluke Calibration, technical note number 8050TN11, August 7, 2009.